

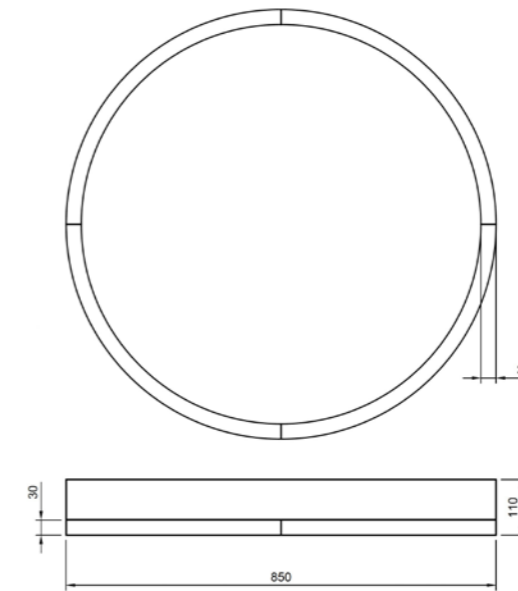

R O U N D 8 5 0 x 1 1 0

DATENBLATT



PRODUKTDATEN

Grösse : 850x110 mm
Gewicht : 10,8 kg
Materialien :
 Gehäuse: Natürliches Massivholz
 Optik: PMMA
 Grundplatte: Aluminium
Optik : Diffusor opal / Mikroprisma
Lichtverteilung : direkt
Treiber : On-Off, DALI, Bluetooth (eingebaut)
Umgebungstemperaturbereich : 0/+35°C
Lebensdauer : L80B10-60 000 Stunden
Installation : Aufbau-, Pendelmontage

WOOD ROUND LED 850x110 DIFFUSE

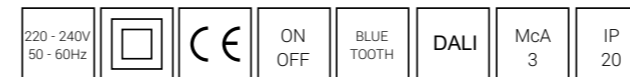

HOLZ OPTIONEN



TECHNISCHE SPEZIFIKATION

ART.-NR.	LEISTUNG	CRI	CCT	LUMEN
WR850x110MR	109 W	> 90	3000 K	10350 lm
WR850x110MR	109 W	> 90	4000 K	11400lm

Bestellbeispiel:

WR850x110MR	-	Leistung	-	CRI / CCT	-	Winkel	-	Holzart	-	Treiber	-	Option
WR850x110MR	-	109	-	930	-	DIFF	-	Eiche	-	On-Off	-	XYZ